



LASER ZTAMP SA DE CV

Tel. 614 499 0133

[ventas@laserztamp.com.mx](mailto:ventas@laserztamp.com.mx)



**NEOPRENE INSPECTION STAMPS**

**PRE-INKED "RC" LIPSTICK**

**LINE NUMBERING STAMPS**

**ALPHANUMERIC STAMPS**

**AUTO NUMBERING MACHINES**

**WATER AND OIL BASE INKS**

**SPECIAL MARKING INKS**

**STEEL STAMPS**

**PEG STAMPS**

**RIBTIPE TYPE SETS**



# Self-Inking Stamps



*The Most Advanced Pre-inked Stamp Technology  
Better Print Quality - Faster Inking*

Available in 33 Sizes and 3 Handle Colors: **Burgundy**, **Soft Green**, and **Blue**



**FL-9** (1-1/4" x 3" - 32mm x 78mm)



**FL-1** (5/8"x1-5/8" - 17mm x 43 mm)



**FL-R22** (2" - 51mm Round)



**FL-8** (1-1/4" x 2-1/8" - 32mm x 55mm)



**FL-4** (7/8" x 2-1/8" - 22mm x 55mm)

FastLight Ink **Colors:** Black, Red, Blue, Violet, Green

Only for use with **FastLight Oil-base Ink** (See Inks Page for more Information)

- Elegant High Quality Mounts
- Very Smooth Mechanism, No Squeek
- Up to 50,000 Quality Impressions
- Material resists Warping and Doming
- Ink Cartridges in 5 Colors
- Easily Reinkable in Just Seconds



Stamp impression *must fit* within inner, dotted border.  
For best results, give impression an additional 1/8" margin from inner border.

## Size Chart, Sizes 0 to 13

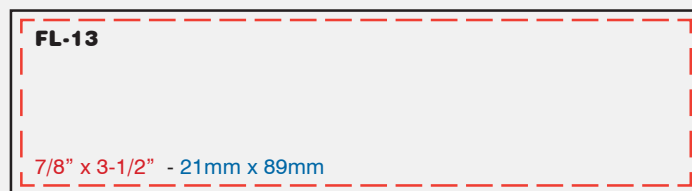
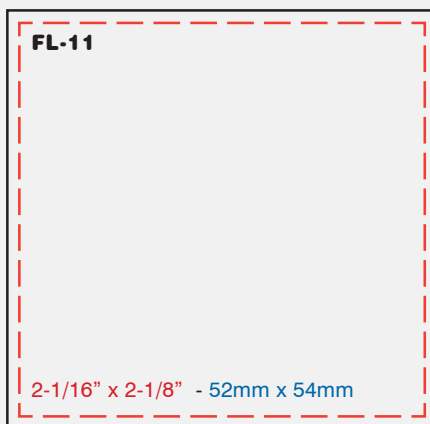
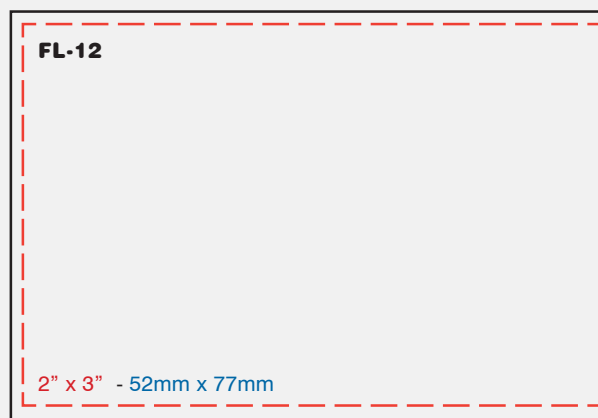
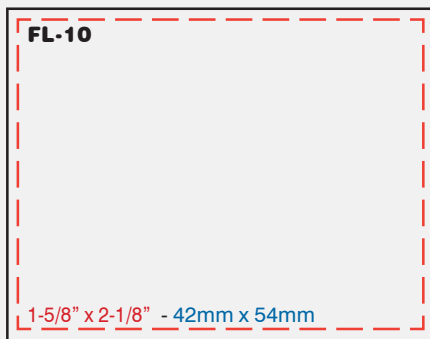
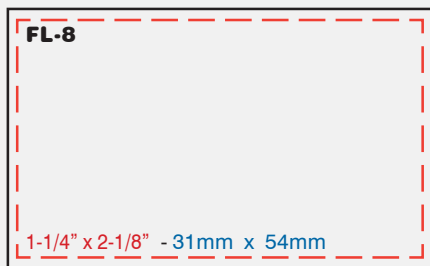
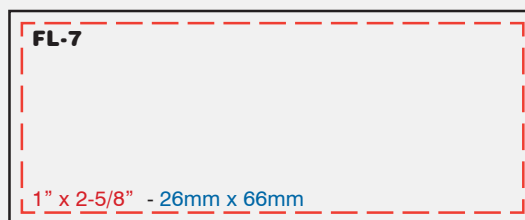
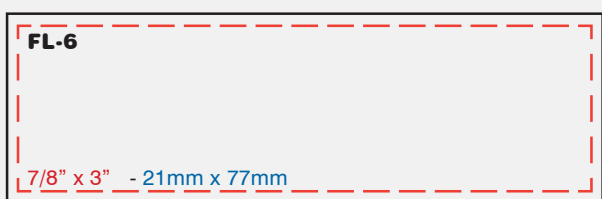
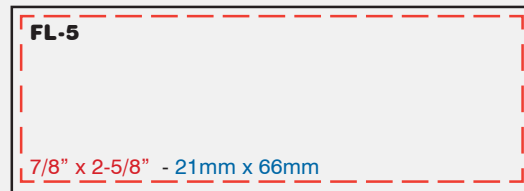
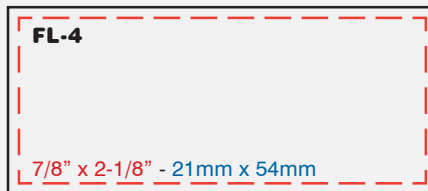
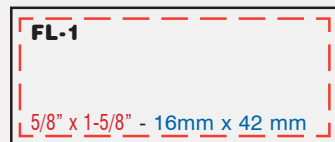
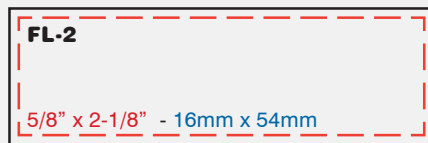
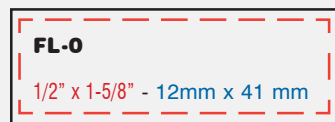



## Size Chart, Sizes 14 - 17 & 27 - 32

Stamp impression *must fit* within inner, dotted border.  
For best results, give impression an additional 1/8" margin from inner border.

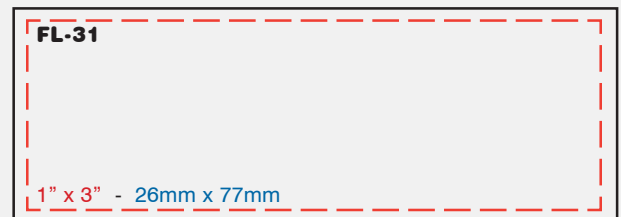
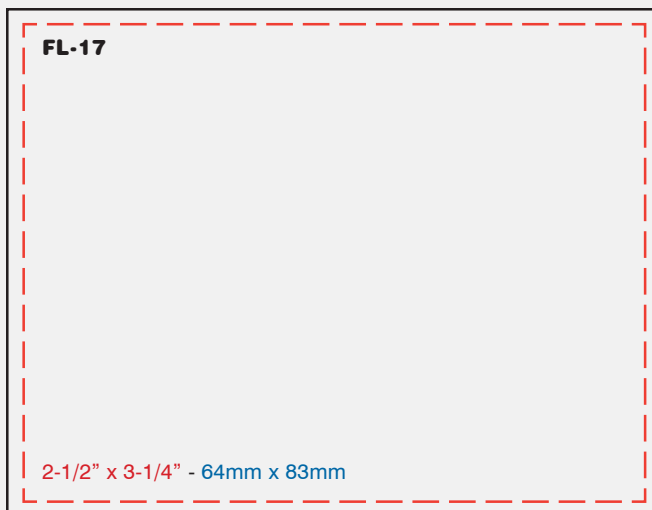
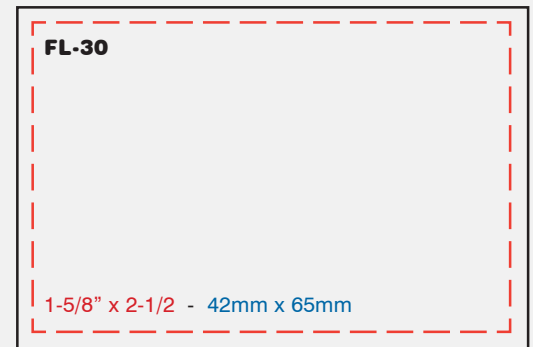
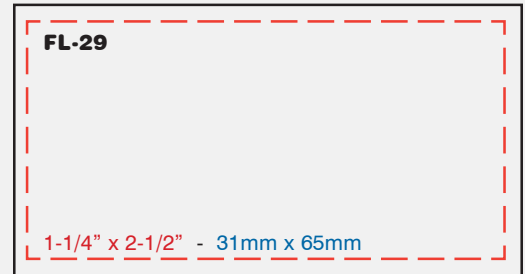
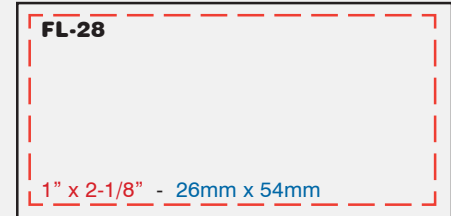
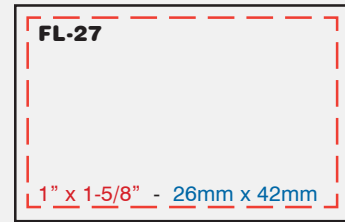
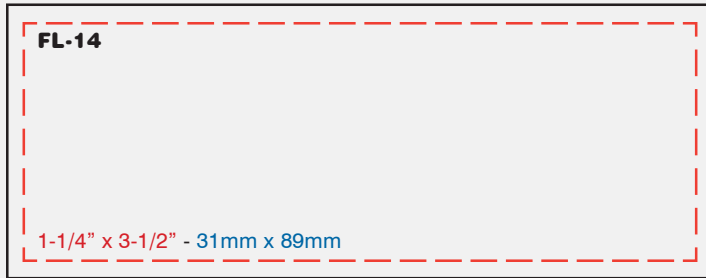



## Size Chart, Sizes 18, 33-34, & R20-R24

Stamp impression *must fit* within inner, dotted border.  
For best results, give impression an additional 1/8" margin from inner border.

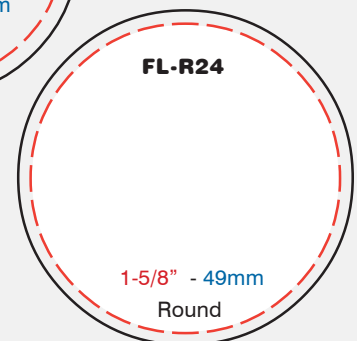
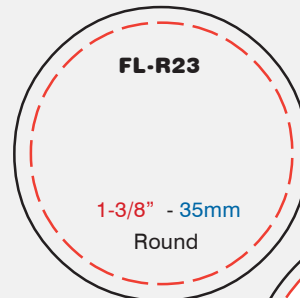
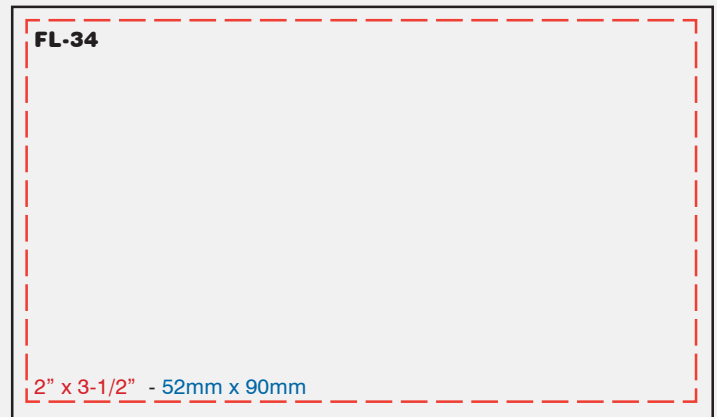
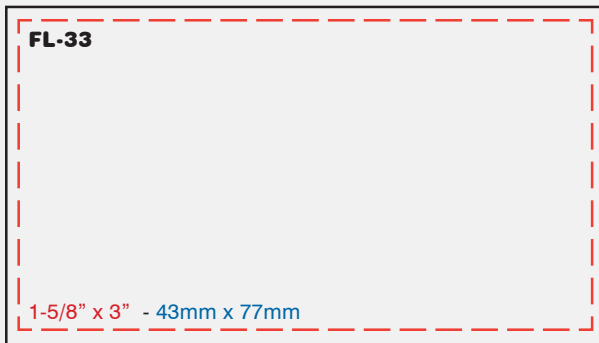
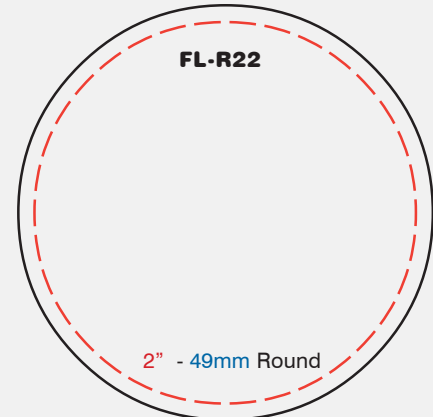
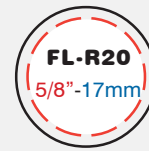

# **“NEOPRENE” INSPECTION STAMPS “W” INSPECTION CASES**



## **The most trusted name in Inspection Stamps**



## **SOLID NEOPRENE PLUG**

***All One Piece - Cannot Come Apart***

**Precision Engraved To Your Exact Specifications**

***Available in 5 Sizes and Two Styles.***

***Western Deluxe with Brass Cap, Western PC with Plastic Cap.***

***Available with or without keyhole and keychain.***

# PRE-INKED "RC" LIPSTICK INSPECTION STAMPS

**FOR ALL POROUS SURFACES**

**COLORS AVAILABLE: Black, Red, Blue, Violet, and Green**

**RE-INKING:** Inking is easy and takes less than one minute. Place Stamp FACE UP and pour a FEW DROPS of W-OIL-BASE INK on surface. Repeat 2 more times. The stamp will make over 20,000 Impressions and can be re-inked

**USE "W"-OIL-BASE INK ONLY!**

(Do Not Over-ink or allow ink to flow into mechanism)

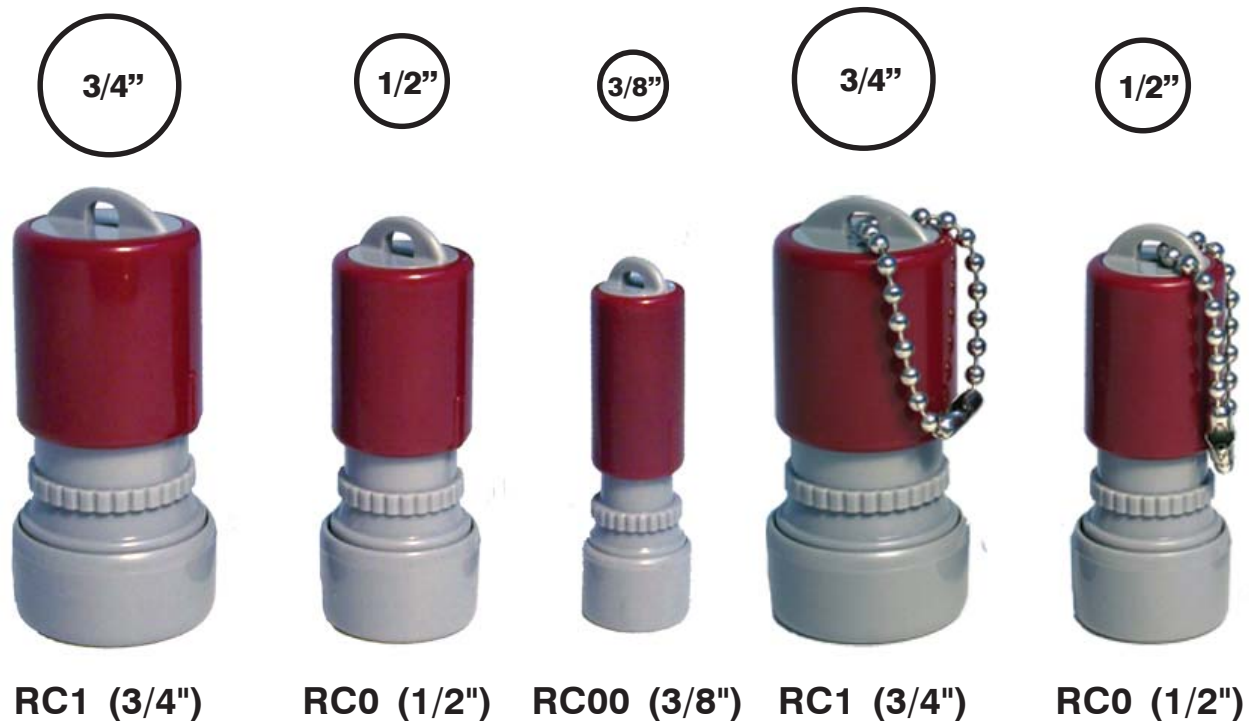

**ADJUSTABLE - RE-INKABLE**

# LINE NUMBERING STAMPS



Line Numbering Stamps are excellent for repeat stamping of changing numbers.

Substitute Alphabet Bands A thru M or N thru Z in any position on special

**Sketches or existing impressions can be faxed.**

**Please call in or email for quote.**

Shaded area indicates sizes and number of bands available on self-inking stamps (bands on No. 3 size conventional self-inking stamps contain 11 characters.) All sizes shown are available as manual stamps.  
\* No. 4 Self-Inking Stamp is available in BDA Style only.

SIZE & STYLE	*	SIZE					CHAR. SIZE	MAX. NO. OF BANDS	
		1"	2"	3"	4"	5"		REG.	SELF-INKER
0X Gothic		1 2 3 4 5 6 7 8 9 0 1 2 3 4 5 6 7 8 9 0 1					3/32"	21	20
00 Gothic		1 2 3 4 5 6 7 8 9 0 1 2 3 4 5 6 7 8 9 0 1					1/16"	22	19
00 Roman		1 2 3 4 5 6 7 8 9 0 1 2 3 4 5 6 7 8 9 0					1/16"	20	18
0 Gothic		1 2 3 4 5 6 7 8 9 0 1 2 3 4 5 6 7 8 9 0					1/8"	19	19
0 Roman		1 2 3 4 5 6 7 8 9 0 1 2 3 4 5 6 7					1/8"	17	16
1 Gothic		1 2 3 4 5 6 7 8 9 0 1 2 3 4 5 6 7 8 9					5/32"	19	18
1 Roman		1 2 3 4 5 6 7 8 9 0 1 2 3 4 5					5/32"	15	15
2 Gothic		1 2 3 4 5 6 7 8 9 0 1 2 3 4 5 6 7					3/16"	17	13
2 Roman		1 2 3 4 5 6 7 8 9 0 1 2 3 4					3/16"	15	11
2 1/2 Gothic		1 2 3 4 5 6 7 8 9 0 1 2 3 4 5 6 7 8 9					1/4"	19	14
2 1/2 Roman		1 2 3 4 5 6 7 8 9 0 1 2 3 4 5					1/4"	15	12
3 Gothic		1 2 3 4 5 6 7 8 9 0 1 2 3 4 5 6					5/16"	16	13
3 Roman		1 2 3 4 5 6 7 8 9 0 1 2 3					5/16"	13	10
*BDA only 4 Gothic		1 2 3 4 5 6 7 8 9 0 1 2					7/16"	13	NOT AVAILABLE IN SELF-INKING STYLE
4 Roman		1 2 3 4 5 6 7 8 9 0 1					7/16"	11	
5 Gothic		1 2 3 4 5 6 7 8 9 0					9/16"	10	
5 Roman		1 2 3 4 5 6 7 8					9/16"	8	
6 Gothic		1 2 3 4 5 6 7 8 9					1 1/16"	9	
7 Gothic		1 2 3 4 5 6 7					7/8"	7	



# ALPHANUMERIC STAMPS



Available in 28-Character (Alphabet-Only Band or Number+Fraction Bands) or 38-Alpha-Numeric (A-Z + 0-9 + period and dash)

Can contain up to 34 bands (in smallest band size! Create small phrases.

Requires stamp pad.

## 28-Character Alphabet-Only Band Size Chart

	1"	2"	3"	4"	5"	Max. No. of bands
(Gothic)	1 2 3 4 5 6 7 8 9 0 A B C D E F G H I J K L M N					34
(Gothic)	1 2 3 4 5 6 7 8 9 0 A B C D E F G H I J K L M N					24
(Roman)	1 2 3 4 5 6 7 8 9 0 A B C D E F G H I J K L					30
(Gothic)	1 2 3 4 5 6 7 8 9 0 A B C D E F G H I J K L M N O P R S T					30
(Roman)	1 2 3 4 5 6 7 8 9 0 A B C D E F G H I J K L M N O P					26
(Gothic)	1 2 3 4 5 6 7 8 9 0 A B C D E F G H I J K L M N O P R S T					30
(Roman)	1 2 3 4 5 6 7 8 9 0 A B C D E F G H I J K L M N					24
(Gothic)	1 2 3 4 5 6 7 8 9 0 A B C D E F G H I J K L M					23
(Roman)	1 2 3 4 5 6 7 8 9 0 A B C D E F G H I					19
(Gothic)	1 2 3 4 5 6 7 8 9 0 A B C D E F G H I					20
(Roman)	1 2 3 4 5 6 7 8 9 0 A B C D E					16
(Gothic)	1 2 3 4 5 6 7 8 9 0 A B C D E F G					17
(Roman)	1 2 3 4 5 6 7 8 9 0 A B C D					14

Shaded area indicates what is available as a Self-Inker.

## 38-Character AlphaNumeric Band Size Chart

For complete versatility...each band contains 38 characters: the complete alphabet, the figures 0 through 9, plus a period and a dash. See table below for maximum capacity of bands per stamp.

To order, Specify: 1) Type Size 2) Number of Bands & 3) Style Number of Bands in the order you want them.

	1"	2"	3"	4"	5"
(Gothic)	1 2 3 4 5 6 7 8 9 0 A B C D E F G H I J K L M N O P Q R S T U V W X Y Z . -				
(Gothic)	1 2 3 4 5 6 7 8 9 0 A B C D E F G H I J K L M N O P Q R S T U V W X Y Z . -				
(Roman)	1 2 3 4 5 6 7 8 9 0 A B C D E F G H I J K L M N O P Q R S T U V W X Y Z . -				
(Gothic)	1 2 3 4 5 6 7 8 9 0 A B C D E F G H I J K L M N O P Q R				
(Roman)	1 2 3 4 5 6 7 8 9 0 A B C D E F G H I J K L M N O P				
(Gothic)	1 2 3 4 5 6 7 8 9 0 A B C D E F G H I J K L M N O P Q R				
(Roman)	1 2 3 4 5 6 7 8 9 0 A B C D E F G H I J K L				
(Gothic)	1 2 3 4 5 6 7 8 9 0 A B C D E F G H I J K L M N				
(Roman)	1 2 3 4 5 6 7 8 9 0 A B C D E F G H I J				

Shaded area indicates sizes and number of bands available on BDA Self-Inking Stamps. BDA Self-Inking Stamps are available in Gothic only.

# AUTO NUMBERING MACHINES

## Auto Numberers

An excellent tool for stamping of continuously incrementing numbers.

From 5 to 13 wheels in either 3/16" or 11/64" sizes, and two typefaces (Roman and Gothic)

Numberers contain lever to set how many presses are required to advance the number (0=never--always print same number, 1=advance after single press, 2=advance after 2 presses, etc).

Stamp Pad is required.



123456



12345

## Tally Counter

Handy for keeping accurate count manually. Counts up to 9999 times.



## Pro-Line Heavy-Duty Numbering Machine

MODEL	WHEELS	MOVEMENTS	AUTO MOVEMENTS	TYPESTYLE	STYLE	SIZE
A-01	10 wheels	Lever Action	6 wheels	1234567890	Roman	3/16"
A-31	13 wheels	0,1,2	6 wheels	1234567890123	Roman	11/64"
A-21	12 wheels	0,1,2	6 wheels	123456789012	Roman	11/64"
A-11	11 wheels	0,1,2	6 wheels	12345678901	Roman	3/16"
B-37	10 wheels	0,1,2	6 wheels	1234567890	Roman	11/64"
B-71	9 wheels	0,1,2,3,4,6,12	6 wheels	123456789	Roman	11/64"
B-78	8 wheels	0,1,2,3,4,6,12	6 wheels	12345678	Roman	3/16"
C-77	7 wheels	0,1,2,3,4,6,12	6 wheels	1234567	Roman	11/64"
C-71	6 wheels	0,1,2,3,4,6,12	6 wheels	123456	Roman	3/16"
C-72	6 wheels	0,1,2,3,4,6,12	6 wheels	123456	Gothic	3/16"
C-75	6 wheels	0,1,2,3,4,6,12	5 wheels	A12345	Roman	3/16"
D-51	5 wheels	0,1,2,3,4	5 wheels	12345	Roman	11/64"
MM-21	6 wheels	0,1,2,3,4	5 wheels	1 2 3 4 5 6	Gothic	3/16"

## Standard-Duty Numbering Machine

MODEL	WHEELS	MOVEMENTS	AUTO MOVEMENTS	TYPESTYLE	STYLE	SIZE
70005	5 wheels	0,1,2,3,4,6,12	5 wheels	01234	Roman	11/64"
70006	6 wheels	0,1,2,3,4,6,12	6 wheels	012345	Roman	3/16"

# Water and Oil Base Inks

## “W” Oil-Base Marking Ink

### *Deep, vibrant Impression colors*

- Colors Available: **Black, Red, Blue, Green, or Purple**
- Premium oil-base stamp ink for easy re-inking
- Resists drying for prolonged inking life for more impressions per re-inking
- For Pre-inked stamps, NOT for stamp pads or self-inkers or FastLight
- Use only with: “W” Pre-Ink Stamps and RC Lipstick Stamps



## “W” Water-Base Marking Ink

### *For Manual Stamping and Self-Inks*

- Colors Available: **Black, Red, Blue, Green, or Purple**
- For Ink Pads and Self-Inking type stamps, NOT for pre-inked stamps
- Premium water-base stamp ink for easy re-inking
- Resists drying for prolonged inking life
- Works well in hot and humid environments
- Available in 2 oz size, quart, or gallon.
- For use with: W FastStamps, Die Plates, Inspection, Regular Rubber and Pads



## FastLight Oil-Base Ink

### *Special Formula for FastLight Brand*

- Colors Available: **Black, Red, Blue, Green, or Purple**
- Quick-dry formula -- dries in 20 seconds or less
- Premium oil-base stamp ink for easy ink/re-ink of FastLight series
- Deep, vibrant colors for your stamp impressions
- Resists drying for prolonged inking life and more impressions per re-inking
- Use only with FastLight Brand Pre-Ink Stamps



## FastLight Indelible Ink

### *Indelible Formula for FastLight Brand*

- Colors Available: **Black, Red, Blue, Green, or Yellow**
- Permanent marking -- requires acetone, alcohol or paint thinner to remove
- For non-porous surfaces such as glass, metal, ceramics, hard plastic, etc
- SAFE for CDs, cellophane, soft plastics, glossy photos, polished surfaces, etc.
- Use only with FastLight Brand Pre-Ink Stamps



# Special Marking Inks

## Non-Porous “W” Super Ink

### For Permanent Parts Marking

- Colors Available: **Black, Red, Blue, Green, Yellow, White**
- Special formula non-porous ink is permanent ink for non-porous surfaces
- Excellent for inspection purposes and permanent industrial parts marking
- Permanent: not affected by oil or water and resists cleaning agents
- Also known as “W” Non-Porous **Permanent Ink**
- Also available in invisible formula: ultraviolet reactive - glows with UV light
- Use only with “W” Super Stamps



## Indelible Invisible Ink

### For Permanent Parts Marking

### For Use with Ultra-Violet Light

- Special formula invisible super ink is permanent ink for non-porous surfaces
- This ink is the U.V. (invisible) version of our Non-Porous “W” Super Ink
- Invisible ink formula is ultraviolet reactive: glows **Orange-Yellow** with UV light
- Excellent for inspection purposes and permanent industrial parts marking
- Completely invisible to regular light – perfect for surreptitious marking
- Permanent: not affected by oil or water and resists cleaning agents
- Also known as “W Super” Invisible Ink

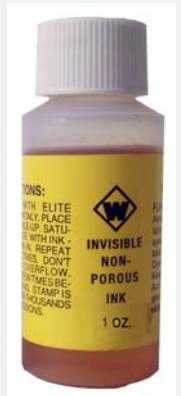

## Invisible Body Ink

### For Use with Ultra-Violet Light

- **Completely invisible to regular light -- only visible under U.V. light**
- Tested and approved for safe use on skin, but recommended only for hands and forearms
- Super fast drying: dry-to-touch within fifteen seconds of application
- Invisible ink formula is ultraviolet reactive: glows **Orange-Yellow** with UV light
- Semi-permanent: water and sweat resistant, but washes off with soap and water
- Self-evaporating: impression will evaporate and disappear in three to five days
- Excellent for entry/exit marking for amusement parks, clubs, fairs, etc.
- Also known as Invisible **Indelible** Body Ink



## “W” Ink Reactivator

### Rejuvenates Stamp Impression Surface

- Also known as stamp Thinner or “Rejuvenator”
- Removes permanent impression markings made by non-porous permanent inks
- Removes non-porous ink buildup on stamp surface to rejuvenate impression quality



# Inks to Stamp, Sizes, Colors

## Ink-to-Stamp Cross Reference

### Ink - Stamp XRef

	FastStamp	"W" Pre-Plate Die	Inspection Pre-Ink	FastLight	"RC" Super	Regular Lipstick Rubber	"W" Invisible, Stamp Pad	"W" Invisible, Body
"W" Oil-Base			●			●		
"W" Rubber Stamp	●	●		●			●	●
FastLight Oil-Base				●				
FastLight 510 Indelible				●				
Non-Porous "W" Super					●			
Indelible Invisible								●
Invisible Body								●
"W" Ink Reactivator			●	●	●	●	●	●

### Ink Sizes

	1/4	1/2	1oz	2oz	4oz	8oz	Pint	Qt	Gal
"W" Oil-Base	○	○	○	○	○	○	○	○	○
"W" Rubber Stamp				○				○	○
FastLight Oil-Base			○	○				○	○
FastLight 510 Indelible				○					
Non-Porous "W" Super	○	○	○	○		○	○	○	○
Indelible Invisible	○	○	○	○		○	○	○	○
Invisible Body	○	○	○	○		○	○	○	○
"W" Ink Reactivator	○	○	○	○		○	○	○	○

Ink Bottles ship with either a Cap Spout or Built-In Dropper



**Note:** Actual packaging and labeling may look different than sample images and will depend upon bottle availability.

### Ink Colors

	Black	Red	Blue	Green	Purple	Yellow	White
"W" Oil-Base	●	●	●	●	●		
"W" Rubber Stamp	●	●	●	●	●		
FastLight Oil-Base	●	●	●	●	●		
FastLight 510 Indelible	●	●	●	●		●	○
Non-Porous "W" Super	●	●	●	●		●	○
Indelible Invisible	Glows Orange-Yellow with UV Light						
Invisible Body	Glows Green* with UV Light						

\*Invisible Body ink has other UV glow colors. Call for availability.

### Other Inks Available Upon Request:

**Ink In Special Colors**

Price Marking Ink

Postage Marking Ink

Frozen Food Package Ink

Meat and Cheese Marking

Acid-Base Inks

High Temperature Ink

Indelible Laundry Ink

**Can't Find It? Call & Ask**

# STEEL STAMPS

Made with Best Quality "Highspeed Steel"  
**FOR HAND & MACHINE STAMPING**

*"The Best Quality Steel Stamp anywhere in the World"*

*"Better than Any Stamp you have ever used — We guarantee it!"*

*Please Call for Quotation*

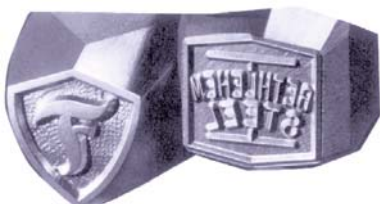

FLAT FACE



ROUND FACE



DOT FACE



PUNCHPRESS STAMP



TYPE HOLDER



HAMMER STAMP



HAMMER INSERT STAMP



STEEL TYPE



STEEL INSERT STAMPS



STEEL ALPHABET & FIGURE SET



HIGHSPEED STEEL  
INSPECTION STAMPS

**OUR QUALITY:** Highspeed Steel Stamps will outlast Regular Steel Stamps by 2 to 3:1. Eliminates Costly Production Breakdowns, Saving you Time and Money. Highspeed Steel Stamps are guaranteed to be the finest quality available in the world.

## PEG STAMPS



Great for Hard-to-Reach Places

Wood peg for high durability.

Can be pole-mounted to extend reach.

May be drilled, strapped or glued for complex or unique stamping projects.



Impression surface may be any size and shape -- not constricted by sizing charts.



# RIBTYPE TYPE SETS

In the RIBtype® system, ribs on the back of the type interlock with ribs on the marking device. This allows for fast changes of text, which is ideal for date coding and lot number changes. Graphics can also be incorporated in the type for product and brand identification.



Sample Individual Ribtype Characters

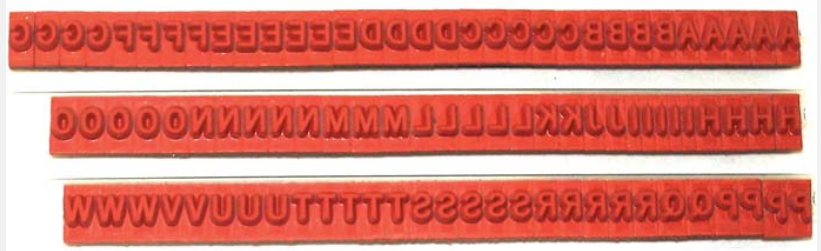

Sample of an entire Ribtype Alphabet

## Available in Four Basic Typesfaces:

“A” - Regular Typestyle (Trade Gothic Regular)

“B” - Regular, Condensed (News Gothic Roman Condensed)

“U” - Bold (CG Alpin Gothic #3)

“G” - Bold, Condensed (CG Alpin Gothic #1)

**See the next page for type samples, sizes and corresponding item numbers**

Order by Selecting a type style (A, B, U, or G), and type size from the next page. Once you know your type style and have selected a size, find the correct item number, such as “A17”, “B10”, “U77”, or “G78.”

Then, select your type set of choice from the right-most chart on the next page. For example, if you want an Alpha-numeric set, choose the “T” 5A or “T” 3A set. The right-most chart indicates that the “T” 5A set contains 136 pieces, and also shows how many of each character are in this set.

## Available in Four Materials for Various Impression Conditions



**NATURAL RUBBER:** is best for general purpose use with alcohol and water-based inks. It is available in standard 50 durometer or soft 30 duro.

**BLACK BUNA:** This oil and acid resistant material is best for use with oil-based inks or when the type is exposed to petroleum products.

**GREEN PVC:** This oil and acid resistant for printing small text on plastic or film and for printing on abrasive surfaces such as Tyvek or brake shoes.

**SILICONE:** This blue-and-white material is for use with thermal ink-transfer printers and for hot stamping.



# RIBTYPE TYPE SETS

STYLE & SIZE	TYPE SAMPLE showing approximate characters per inch	Type Face Height	No. of Ribs	Similar to other Nos.
A7	RIBTYPE 123456789012	1/16" 1.59mm	2	07
A8	RIBTYPE 1234567	5/64" 1.98mm	2	08
A9	RIBTYPE 12345	7/64" 2.78mm	2	09
A10	RIBTYPE 123	1/8" 3.18mm	2	010
A11	RIBTYP 123	9/64" 3.57mm	2	011
B11	RIBTYPE 123456	9/64" 3.57mm	2	011C
A12	RIBTY 12	3/16" 4.76mm	2	012
B12	RIBTYPE 123	3/16" 4.76mm	2	012C
A13	RIBTY1	1/4" 6.35mm	3	013
B13	RIBTY 12	1/4" 6.35mm	2	013C
A14	RIB12	5/16" 7.94mm	3	014
B14	RIBTY3	5/16" 7.94mm	3	014C
A15	RIB3	3/8" 9.53mm	3	015
B15	RIBT4	3/8" 9.53mm	3	015C
A15 1/2	R14	7/16" 11.1mm	4	015 1/2
A16	R12	1/2" 12.7mm	4	016
B16	RA-3	1/2" 12.7mm	4	016C
A17	R2	5/8" 15.9mm	5	017
B17	RA1	5/8" 15.9mm	5	017C
A18	R1	3/4" 19.0mm	6	018
B18	R-1	3/4" 19.0mm	6	018C

STYLE & SIZE	TYPE SAMPLE showing approximate characters per inch	Type Face Height	No. of Ribs	Similar to other Nos.
U70	RIBTYPE 12345	1/8" 3.18mm	2	070
U71	RIBTYPE 1234	5/32" 3.97mm	2	071
U72	RIBTY 123	3/16" 4.76mm	2	072
U73	RIBT 123	1/4" 6.35mm	2	073
G73	RIBTYP 123	1/4" 6.35mm	2	073C
U74	RIBT 12	5/16" 7.94mm	3	074
G74	RIBTY 12	5/16" 7.94mm	3	074C
U75	RIB 23	3/8" 9.53mm	3	075
G75	RIBT 12	3/8" 9.53mm	3	075C
U76	RI13	1/2" 12.7mm	4	076
G76	RIB12	1/2" 12.7mm	4	076C
U77	RI3	5/8" 15.9mm	5	077W
G77	RIB1	5/8" 15.9mm	5	077
U78	R2	3/4" 19.0mm	6	078W
G78	RI3	3/4" 19.0mm	6	078
U79	R1	15/16" 23.8mm	7	
G79	R3	15/16" 23.8mm	7	079

CHARACTERS:	A	B	C	D	E	F	G	H	I	J	K	L	M	N	O	P	Q	R	S	T	U	V	W	X	Y	Z
"1" 5A sets	5	4	5	4	6	4	4	4	5	2	2	5	3	5	5	4	2	5	5	5	3	2	3	2	3	2
"1" 3A sets	3	2	3	2	4	2	2	2	3	2	1	2	2	3	3	2	1	3	3	3	2	2	2	1	2	1
"1" 5F Number Assortment For Styles A11 and Smaller	5																									
"1" 4F Number Assortment For Styles A12 and Larger	4																									
"1" 5P Value Pack Number Assortment For Styles A11 and Smaller	15																									
"1" 5V Value Pack Number Assortment For Styles A12 and Larger	12																									
	1	2	3	4	5	6	7	8	9	0	.	,	-	&	\$	'	/	¢	Total Pieces							
	138	136	136	136	136	136	136	136	136	136	136	136	136	136	136	136	136	136	136	136	136	136	136	136	136	136

Type Sizes, Styles and Item Numbers

Note: samples above are slightly smaller than actual size -- graph was scaled to fit catalog page.

Typeset Contents